

ACCUSLIDE™

EXPANDABLE ROOM SYSTEM



SERVICE MANUAL



TABLE OF CONTENTS

I. TROUBLESHOOTING 2
- Section 1.01: Common Problems/Solutions..... 2

II. GETTING STARTED 5
- Section 2.01: Tools You Will Need..... 5
- Section 2.02: Cable Adjustment..... 6

III. SERVICE PROCEDURES 9
- Section 3.01: Cable Replacement..... 9
- Section 3.02: Wipe Installation..... 12
- Section 3.03: Jamb Clamp Replacement..... 13
- Section 3.04: Manually Moving the Room..... 14

IV. SERVICEABLE ITEMS 15
- Section 4.01: Replacement Kits..... 15



I. TROUBLESHOOTING

1.01 COMMON PROBLEMS / SOLUTIONS

PROBLEM: Motor does not run or make any noise.

Cause 1: *Dead battery*

Solution: Charge or replace battery.

Cause 2: *Open circuit or faulty switch*

Solution: Check switch, fuse & circuit breaker.

Cause 3: *Bad Motor or Controller*

Solution: Replace the Motor or Controller.

PROBLEM: Motor runs, but slide room does not move.

Cause 1: *Cable(s) have become detached*

Solution: Check tension of all cables. Open access panel and re-adjust. Place grommet or screw in standoff bracket to secure the cable (*refer to section 2.02*).

Cause 2: *Chain is caught on a bracket*

Solution: Open access panel to identify the problem. Adjust cable tension. Tighten all 4 jamb nuts. Place nut anti-vibration keeper on cable nuts (8).

Cause 3: *Chain is off the sprocket*

Solution: Open access panel to identify the problem. Put chain back on sprocket. Re-adjust cable tension, tighten all jamb nuts (4). Place nut anti-vibration keeper on cable nuts (8).

Cause 4: *Shaft key is broken*

Solution: Inspect damage and replace all damaged parts.

PROBLEM: Loose Cable – Sagging 1 or more inches, or hanging.

Cause 1: *Adjustment nut is too loose or off cable*

Solution: Open access panel, install all nuts with anti-vibration keeper or Locktite, and adjust.

Cause 2: *Cable is loose from connector bracket*

Solution: Open access panel, loosen nut on loose cable and attach to bracket, then adjust. (*refer to section 2.02*)

Cause 3: *Drive chain has too much slack*

Solution: Open access panel & tighten adjustment nuts. (*refer to section 2.02*)

Cause 4: *Broken Cable*



Solution: Call the service department to replace cable. See instructions included in the kit.
(refer to section 2.02)

Cause 5: Room stand-off bracket is loose or off

Solution: Inspect all inside and outside brackets for secure attachment, and repair as required.

PROBLEM: Squeaks while operating.

Cause 1: Cables are too tight

Solution: Open access panel, and adjust tension.

Cause 2: Brackets are not properly aligned

Solution: Align brackets properly and re-adjust.

Cause 3: Friction between pulleys or brackets

Solution: Lubricate corner pulleys & adjust bracket if pulley is interfering.

PROBLEM: Room wipe is torn or missing.

Cause 1: Room or framework is out of square

Solution: Correct the problem and replace wipe. (refer to section 3.02)

Cause 2: Wipe is torn or weathered

Solution: Replace wipe. (refer to section 3.02)

PROBLEM: Room doesn't close completely.

Cause 1: Improper adjustment

Solution: Open access panel, and adjust tension. Refer to adjustment instructions.

Cause 2: Room is hitting an obstruction

Solution: Check for obstructions and correct.

Cause 3: Improper stand-off bracket alignment (cable is kinked)

Solution: Loosen cable nut to allow slack. Remove screws from stand-off and align cable with slot. Re-attach stand-off. Adjust cable tension.



PROBLEM: Loud grinding noise when room operates.

Cause 1: *Screw or foreign object lodged in jamb pulleys*

Solution: Remove jamb clamp and inspect area causing the noise. Remove any loose objects. Inspect pulleys for damage. Replace the cable(s) if any have become frayed due to the problem.

Cause 2: *Cable has jumped to wrong pulley*

Solution: This can only happen in rare circumstances, if it has happened you will need to determine which set of cables it is (of the two, it will be the cable on top).

1. Loosen the appropriate cable adjusting nut to allow slack in the cable.
2. Using a flat tip screw driver or a small narrow tool (it may take 2) move the cable back to the proper pulley. You may need to pry the extrusion out a little to make enough room for the cable to pass the pulley. It is helpful if a second person can push the cable from the opposite side to force the cable away from the pulley.
3. After the cables are on the proper pulleys, re-adjust the cable tension as described.

PROBLEM: Cable is bent and/or frayed at standoff bracket.

Cause: *Standoff bracket was not proper aligned during installation process*

Solution:

1. Remove the tension from the cable via the cable adjustment nut.
2. Remove the screws from the standoff bracket and adjust to the appropriate location.
3. Re-attach standoff bracket and adjust cable tension.
4. Replace the cable if it has become frayed. (*Refer to section 3.01*)



II. GETTING STARTED

2.01 TOOLS YOU WILL NEED



Power Driver



Ratchet & Sockets
Size: 3/8", 7/16"



Two 3/8" Wrenches



Two 7/16" Wrenches



Vice Grips



Flex-Shaft (Included)



Cable Cutters



Crimping Tool

2.02 CABLE ADJUSTMENT

Shipped with your system is a sticker that should be placed near the slide for instructions on adjusting this system. You will notice each cable-chain connector has a colored tag on it corresponding to the colors of the sticker above. The example diagram below is showing the association between cable adjusters and cables.

CABLE ADJUSTMENT INSTRUCTIONS (Colors indicate adjuster brackets)		854202	
IMPORTANT: THIS SYSTEM IS A GIVE AND TAKE SYSTEM. BEFORE TIGHTENING FOR FIT, MAKE SURE YOU HAVE ENOUGH SLACK IN THE OPPOSING CABLES FOR THE REQUIRED ADJUSTMENT.			
LEFT FRONT controls tension for the left side seal when room is out. Top cable screw adjusts the room bottom. <i>[Opposing cable: Left rear top]</i> Bottom cable screw adjusts the room top. <i>[Opposing cable: Left rear bottom]</i>	RED	RIGHT FRONT controls tension for the right side seal when it is in. Top cable screw adjusts the room bottom. <i>[Opposing cable: Right rear top]</i> Bottom cable screw adjusts the room top. <i>[Opposing cable: Right rear bottom]</i>	GREEN
LEFT REAR controls tension for the left side seal when room is in. Top cable screw adjusts the room bottom. <i>[Opposing cable: Left front top]</i> Bottom cable screw adjusts the room top. <i>[Opposing cable: Left front bottom]</i>	BLUE	RIGHT REAR controls tension for the right side seal when it is out. Top cable screw adjusts the room bottom. <i>[Opposing cable: Right front top]</i> Bottom cable screw adjusts the room top. <i>[Opposing cable: Right front bottom]</i>	PURPLE
BAL POWER JAMB		<small>U.S. Patent#: 6254171 Other U.S. and Foreign Patents Pending</small>	

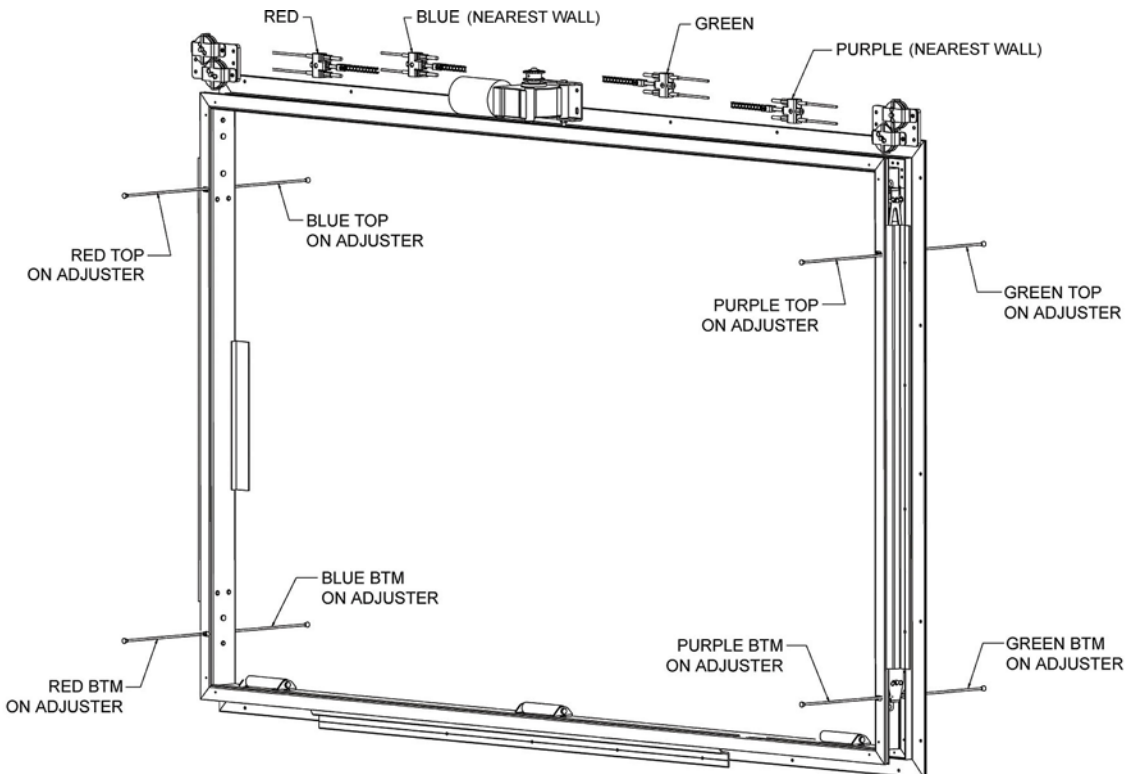
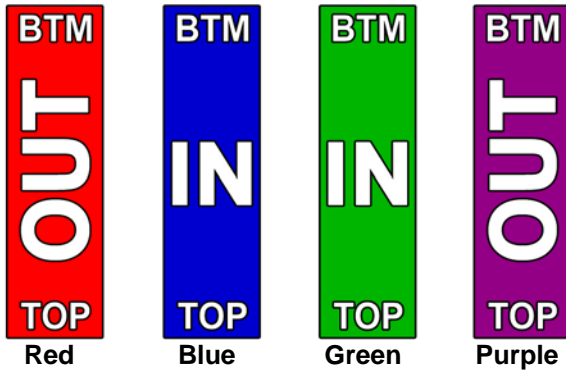

If an ACCU-Slide system is not making the proper seal when it is either open or closed, it needs to be re-adjusted.

The best way to perform an adjustment is to open the room completely in order to have easier access to the cable adjustment brackets. With the room fully extended check top and bottom of both sides to verify all points have sealed. If it is not uniform then an adjustment is necessary.

There are several ways to perform an adjustment depending on room travel and weight. If a room has more than 24 inches of travel it's best to note the distance of adjustment required and then bring the room in 6 to 10 inches before making the adjustment. This will help relieve pressure on the cables making it much easier to turn the adjustment nuts.

1. Before tightening an adjustment nut, make sure the opposing cable has enough slack to allow for the take-up. The opposing cable is the one that has the same corner location but on the opposite side of the wall i.e. (IN Top vs. OUT Top)
2. Tighten the appropriate nut(s) to accomplish the proper seal.
3. Tension the opposing cables until there is enough slack to freely move the cables up and down at least 1 inch overall.
4. When the system is adjusted, tighten all jamb nuts and replace anti-vibration blocks.

In a situation where there are not enough adjustment threads in a cable or chain stud, use the following procedure:

1. Position the room 1 - 2 inches from full outward extension.
2. Turn both chain nuts on the side affected counterclockwise until there is 2 inches of thread showing on both studs.
3. Re-position the cable adjustment nuts to the end of the cable studs.
4. Remove the chain from the sprocket and move the required links to balance the amount of difference in take-up, reconnect chain to sprocket.
5. Take up slack in the chains and cables and re-adjust.

Before going over final adjustments, there are a few things to note about this system...

The Accu-Slide is a give and take system between the cables, if the inside and outside opposing cables are too tight you will cause the motor to be over worked leading to trouble later on.

When the room is seated full out, the OUTSIDE cables should be slack enough to move the cable approximately ½" up or down (1" total movement) by hand. The holding power is actually on the INSIDE cables pulling the standoff brackets tight against the frame.

When the room is seated full in, the INSIDE cables should be slack enough to move the cable approximately ½" up or down (1" total movement) by hand. The holding power is now on the OUTSIDE cables pulling the standoff brackets tight against the frame.

The chains work the same way as the cables, when the room is full in or out, half of the chain on each side of the motor will be slightly slack and half of each chain will be tight.

AFTER ALL FINAL ADJUSTMENTS, TIGHTEN 1/4-20 JAM NUT AGAINST CABLE/CHAIN ADJUSTER BRACKET ON ALL CHAIN CONNECTIONS. TIGHTEN THE JAM NUTS ON THE CABLES BY USING A WRENCH ON BOTH THE JAM NUT AND THE COUPLING NUT - FAILURE TO DO SO WILL RESULT IN A MALFUNCTION OF THE SYSTEM!!!

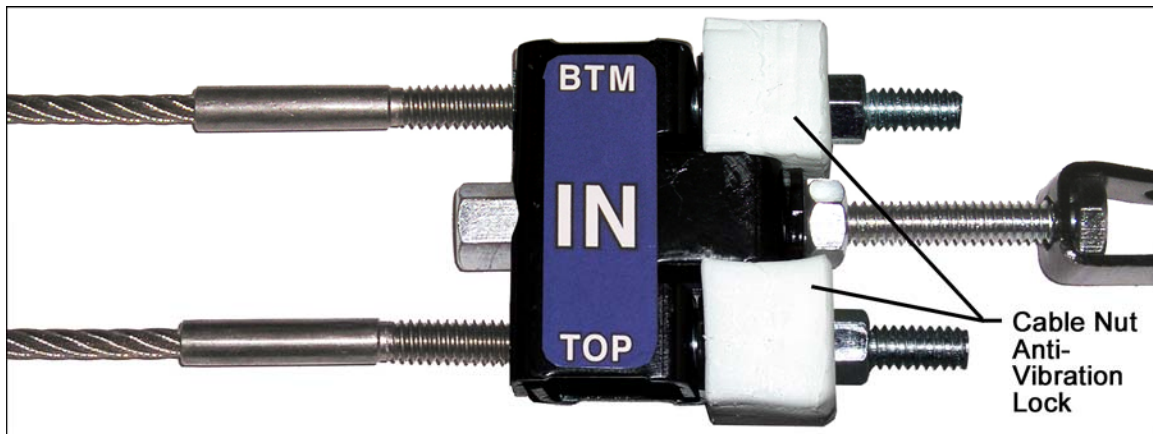

*Cable / Chain connector after final adjustment.
1/4 - 20 Jam Nut tight against connector nut keepers are properly located.*

III. SERVICE PROCEDURES

3.01 CABLE REPLACEMENT

1. Remove the jamb clamp from the interior wall on the side of the cable to be replaced for better access to the cable.
2. Carefully jog the room to approximately half the travel distance. If possible keep tension on the broken cable while the room is moving.
3. Remove the adjustment nut from the broken cable and remove the cable from the bracket.
4. Replace the cable stud with the eyebolt supplied in the cable replacement kit, thread the nut approximately ½" onto the eyebolt.
5. Remove the damaged cable from the standoff bracket and make a clean cut of the cable saving as much of the old cable as possible.
6. Attach the replacement cable to the standoff bracket and replace the keeper grommet. This will prevent the ball end of the cable from retracting into the extrusion.



7. Insert both the replacement cable and the newly cut broken cable into the braided sleeve. If you have spray adhesive available, spray the adhesive on the first 12" of each cable. If adhesive is not available the braided sleeve will still work properly. Tape both ends of the braided sleeve with electrical tape and wrap tightly. **DO NOT BUILD UP TAPE ON THE BRAIDED SLEEVE, THIS CAN CAUSE THE CABLE TO BECOME LODGED IN A PULLEY.** It only takes about 2 wraps on the sleeve to hold, you can place more wraps on the cable area than the sleeve area due to the diameter of the cable vs. the diameter of the sleeve. The tape also ensures that the sleeve will not come off the cable if it hits a bracket during the threading process.

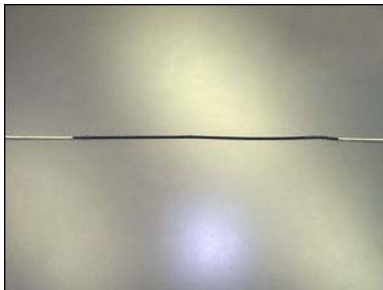

8. Pull the cable from the adjustment bracket until the splice is fully past the last corner pulley. (It is best to have a person feed the cable from the outside while it is being pulled from the inside.)
9. Remove the braided sleeve from the cable and discard the old cable.
10. Insert the "1" bolt into the cable/chain connector bracket and thread the coupling nut on approximately $\frac{1}{2}$ ".
11. Place the ferrule on the cable and loop the cable end through the "1" bolt and back through the other side of the ferrule.



12. Take as much slack out of the cable as possible and place 3 crimps on the ferrule.



13. Replace jamb clamp.
14. Before finishing the adjustment inspect the cable bracket location for proper alignment. Improperly aligned brackets cause most cable failures. In some cases it may be necessary to place a shim under the outside cable stand-off bracket to achieve proper alignment.
15. Tighten the coupling nut to re-adjust the cable tension. If all cables need to be adjusted, follow the adjustment procedures.

ADJUSTMENT:

Left Front Adjust Bracket (OUT): The left front (furthest from the wall) cable adjust bracket controls the tension for the left side of the room to seal when it is open. The top cable screw adjusts the bottom of the room. The bottom cable screw adjusts the top of the room.

Left Rear Adjust Bracket (IN): The left rear (closest to the wall) cable adjust bracket controls the tension for the left side of the room to seal when it is shut. The top cable screw adjusts the bottom of the room. The bottom cable screw adjusts the top of the room.

Right Rear Adjust Bracket (OUT): The right rear (closest to the wall) cable adjust bracket controls the tension for the right side of the room to seal when it is open. The top cable screw adjusts the bottom of the room. The bottom cable screw adjusts the top of the room.

Right Front Adjust Bracket (IN): The right front (furthest from the wall) cable adjust bracket controls the tension for the right side of the room to seal when it is shut. The top cable screw adjusts the bottom of the room. The bottom cable screw adjusts the top of the room.

IMPORTANT: This system is a give and take system. Before tightening for fit, make sure you have enough slack in the opposing cables for the required adjustment.



3.02 WIPE INSTALLATION

1. Remove the old wipe completely, including any old adhesive or rubber. Water may work best for this process.
2. Thoroughly clean the surface with alcohol. It is best to use an activator. We recommend 3M brand.

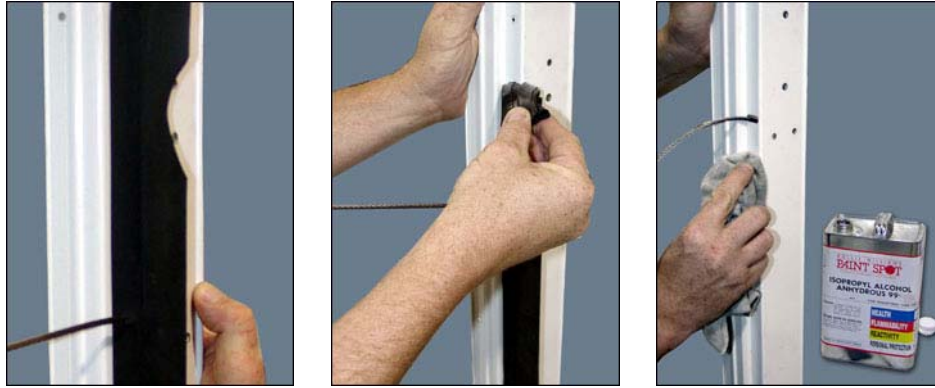

3. Place the new material on the face surface first. Do not stretch the rubber while applying. Punch holes through the rubber at the cable entrance points and attach to the surface.

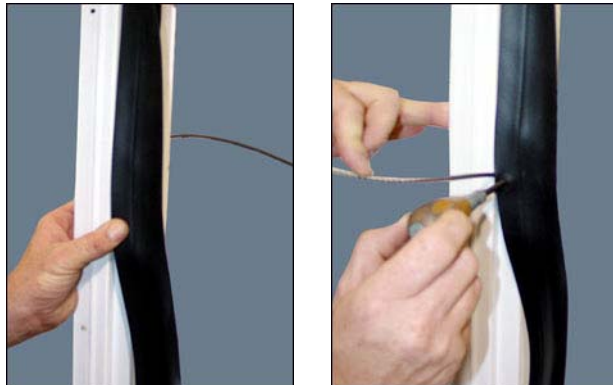

4. Use a roller to press the rubber on. Next, apply the rubber to the inner surface.
5. Use a smooth, hard object that will fit between the room wall and the jamb to press the rubber on that surface.

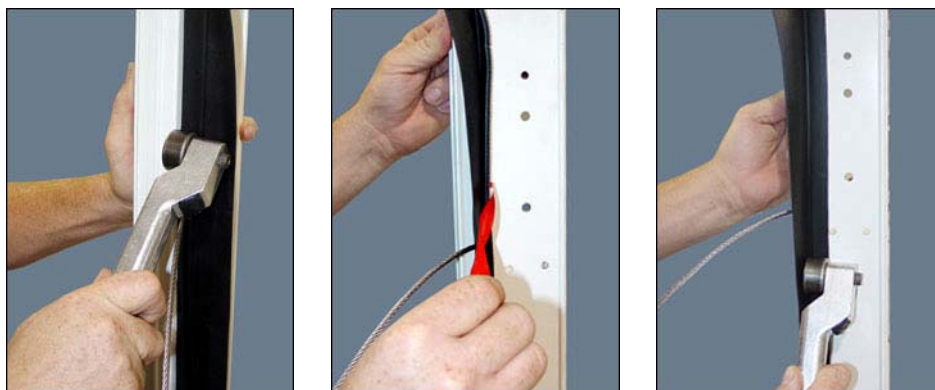

6. Cut in as required for proper fit.



3.03 JAMB CLAMP REPLACEMENT

REMOVAL

1. Remove mounting screws from jamb clamp.
2. Pull back edge of clamp, and remove.

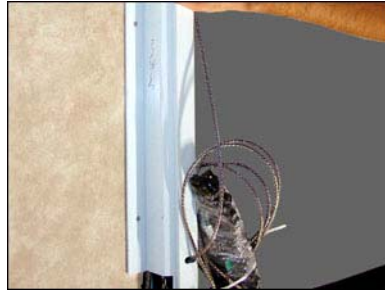

REPLACEMENT

1. Insert edge of clamp into slot.
2. Replace mounting screws.



3.04 MANUALLY MOVING THE ROOM

1. Locate the included flexible shaft in your owner's packet.



2. Attach flexible shaft to the 1/4" hex fitting on the end of the motor.



3. Attach 1/4" socket & ratchet, or drill to the other end, and turn in the proper direction to move the room.



4. If the cables tighten, and the motor is difficult to turn, REVERSE THE DIRECTION. **Over-torquing can happen, resulting in severe damage.**

4.01 SERVICEABLE ITEMS

REPLACEMENT KITS:



Repair Kit 22305
Cable Repair Kit

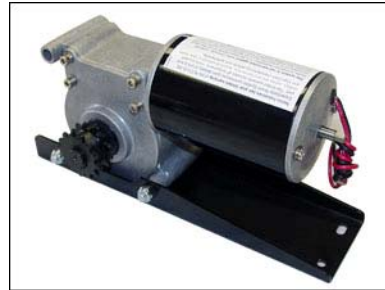

Repair Kit 22307
Motor Repair Kit



Repair Kit 22309
Motor Repair Kit



Repair Kit 22311
Motor Repair Kit

ACCUSLIDE™

EXPANDABLE ROOM SYSTEM

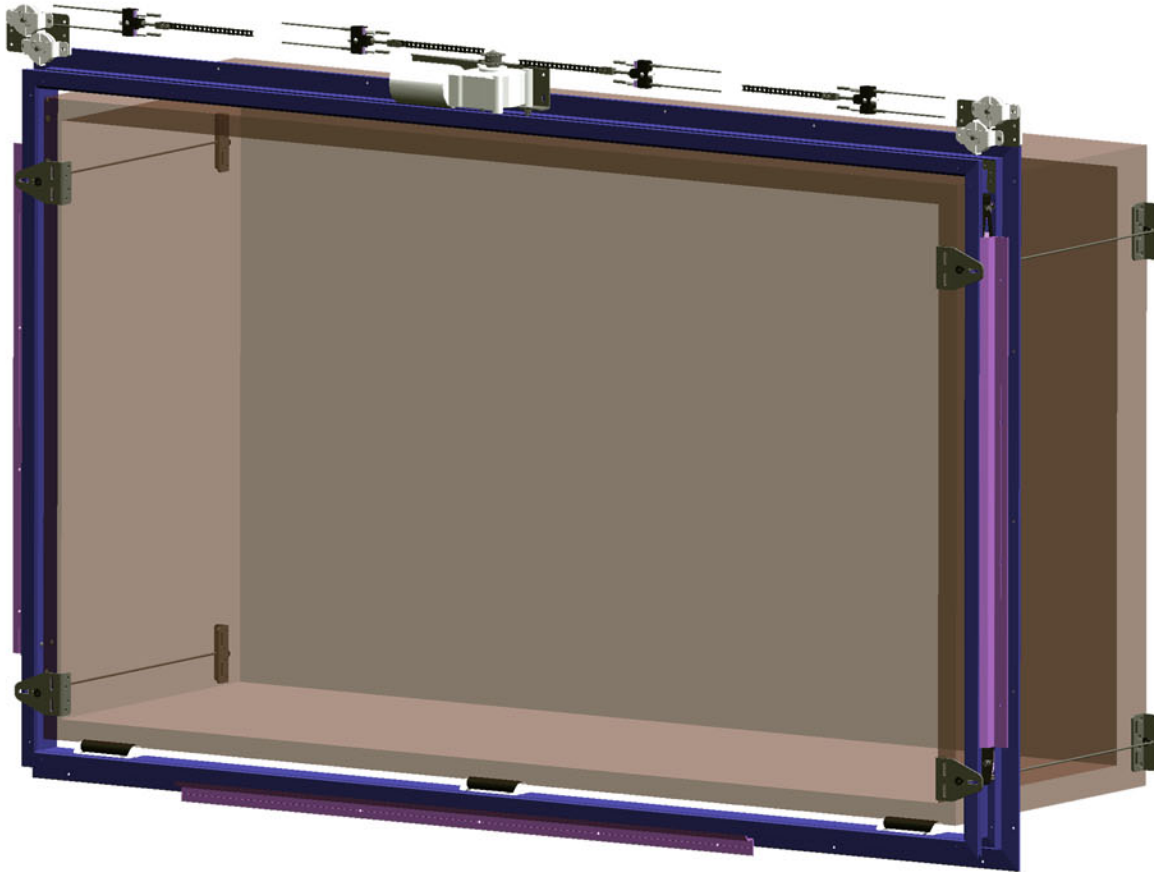

For More Information...

Norco Industries, Inc.
53236 County Road 13
Elkhart, IN 46514
574-262-3400
www.norcoind.com



Copyright 2005 BAL, Inc.
All rights reserved. BAL is a registered
brand of  Norco Industries, Inc.